



**400-8262-889**





■ [Redacted]

■ [Redacted]



2

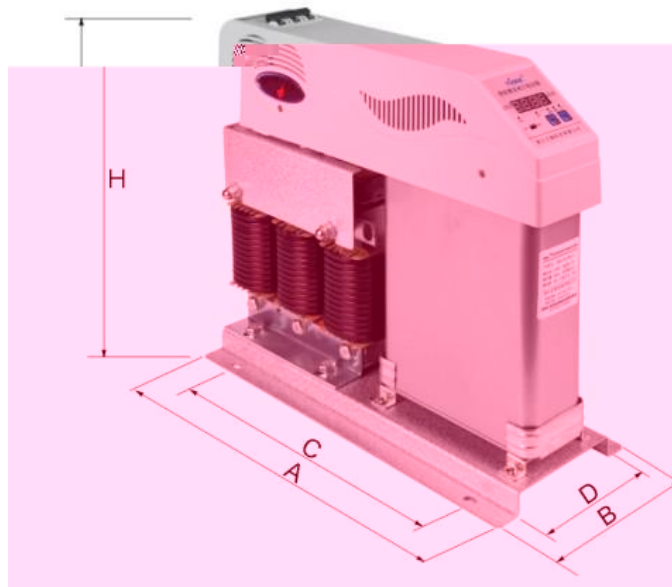

规格		5Kvar		10Kvar		15Kvar		20Kvar		30Kvar		40Kvar		50Kvar		
		共补	分补	共补	分补	共补	分补	共补	分补	共补	分补	共补	分补	共补	分补	
H	外	358	358	358	358	358	358	358	458	458	458	458			465	
A	形尺寸	358	410	410	410	410	410	410	410	440	440	440			445	
B		160	160	160	160	160	160	160	160	190	190	190			190	
C	安装尺寸	310	310	310	310	310	310	310	310	350	350	350			350	
D		140	140	140	140	140	140	140	140	170	170	170			170	

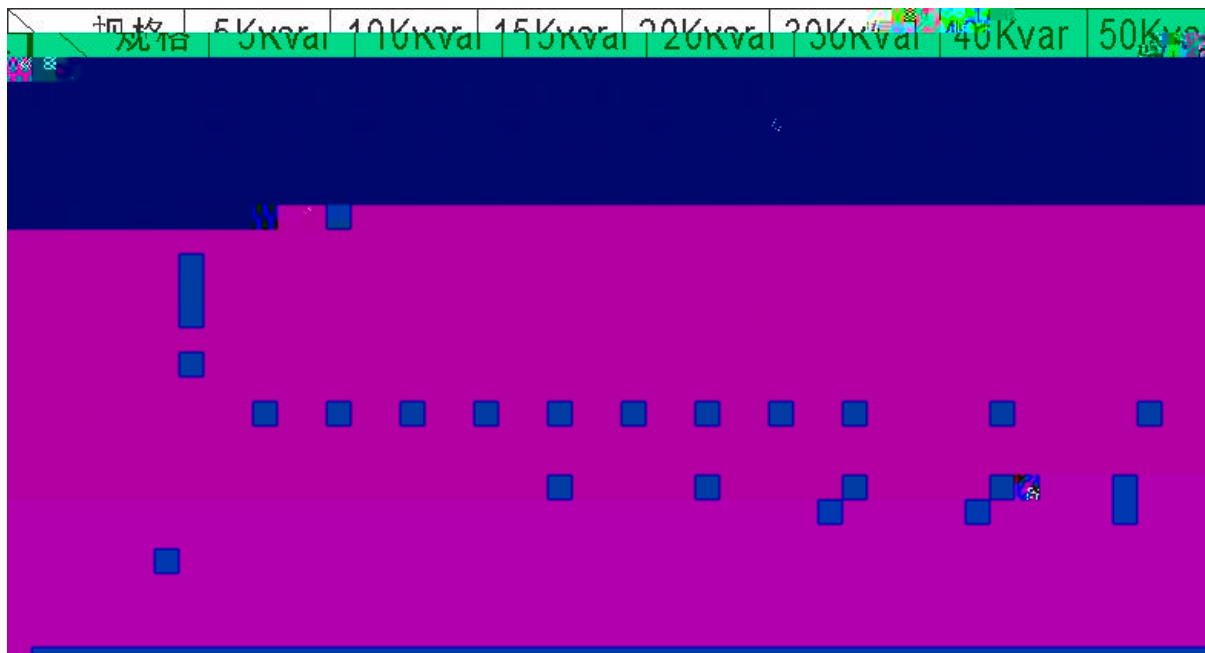

[Redacted text]

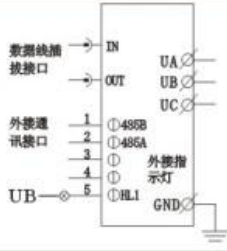
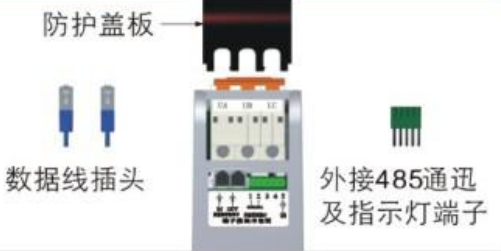
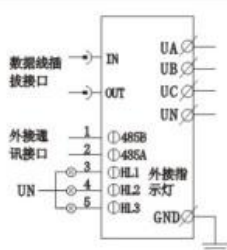
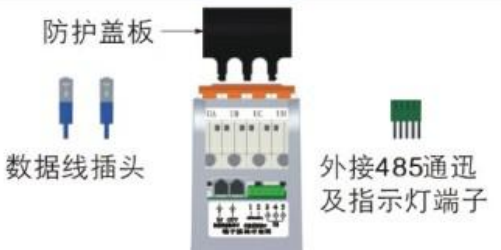
补偿方式	端子图及含义	实物图
三相补偿		
分相补偿		

· [Redacted]

1

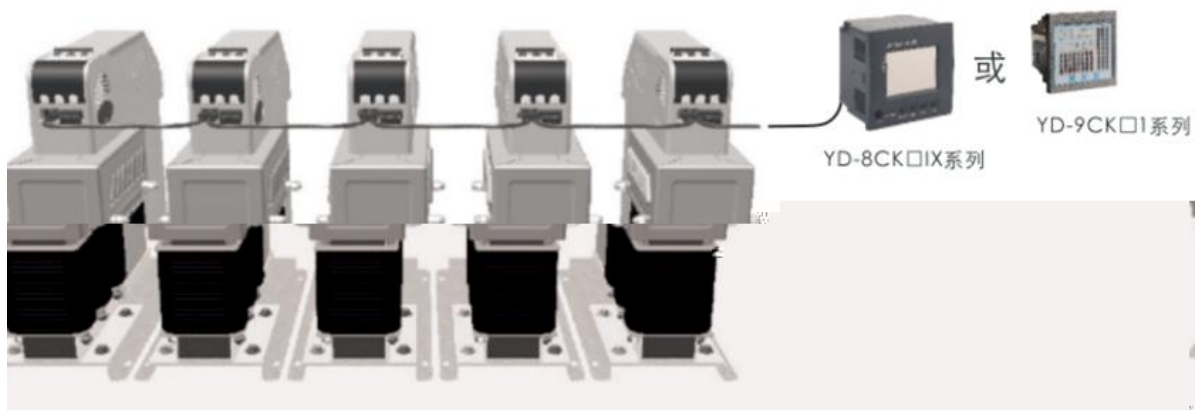
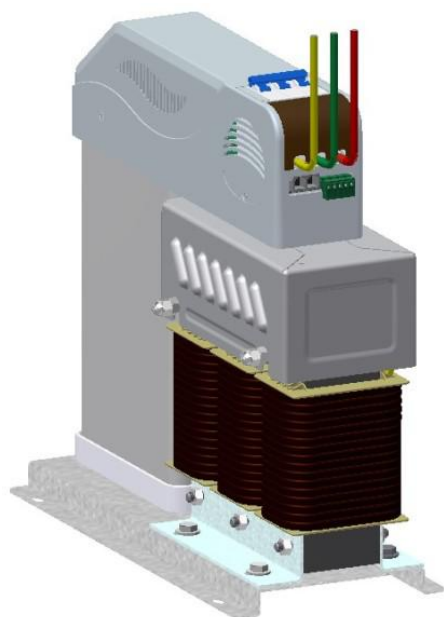
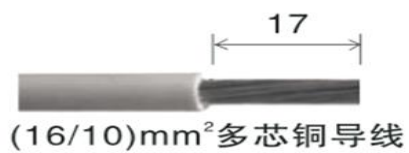

2



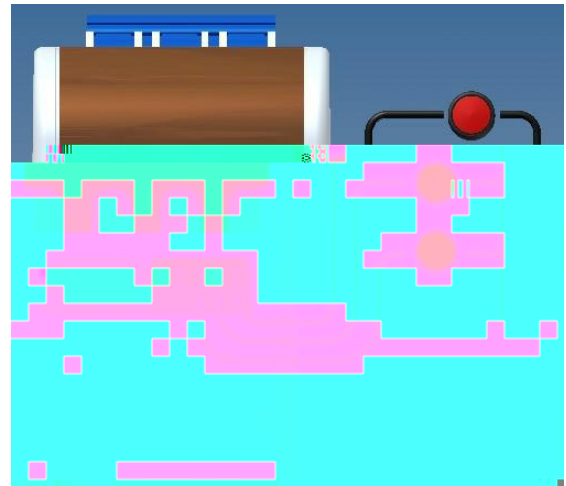
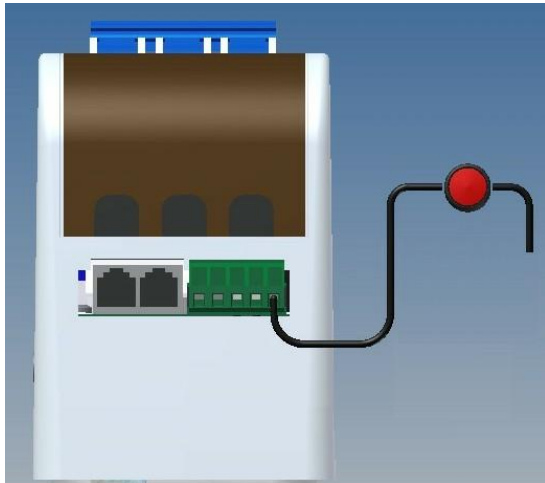

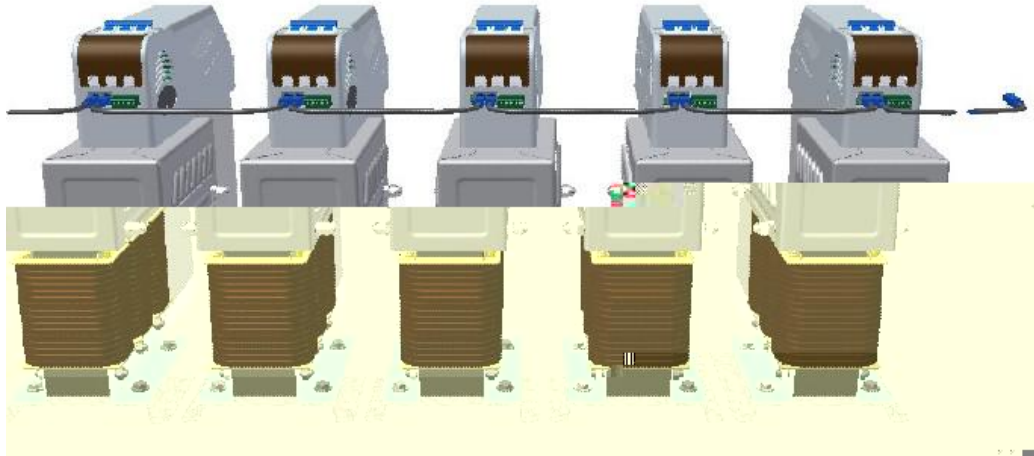

序	型式	长度	实物照片	用途
1	A型	30cm		用于相邻二台产品间的连接
2	B型	70cm		用于上下二层间产品间的连接
3	C型	150cm		用于主辅柜产品间
4	D型	300cm		用于控制器与电容器相连接与状态指示器的连接



## 2.5

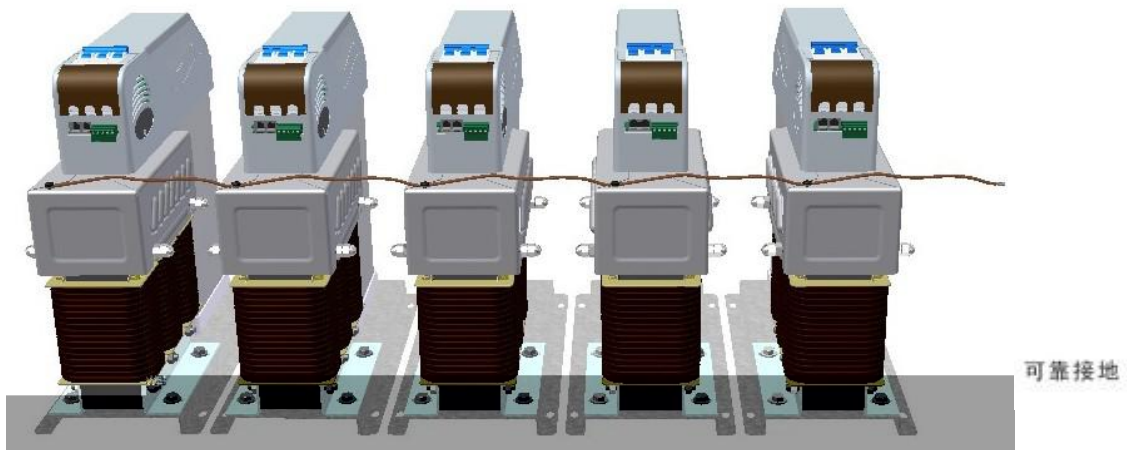



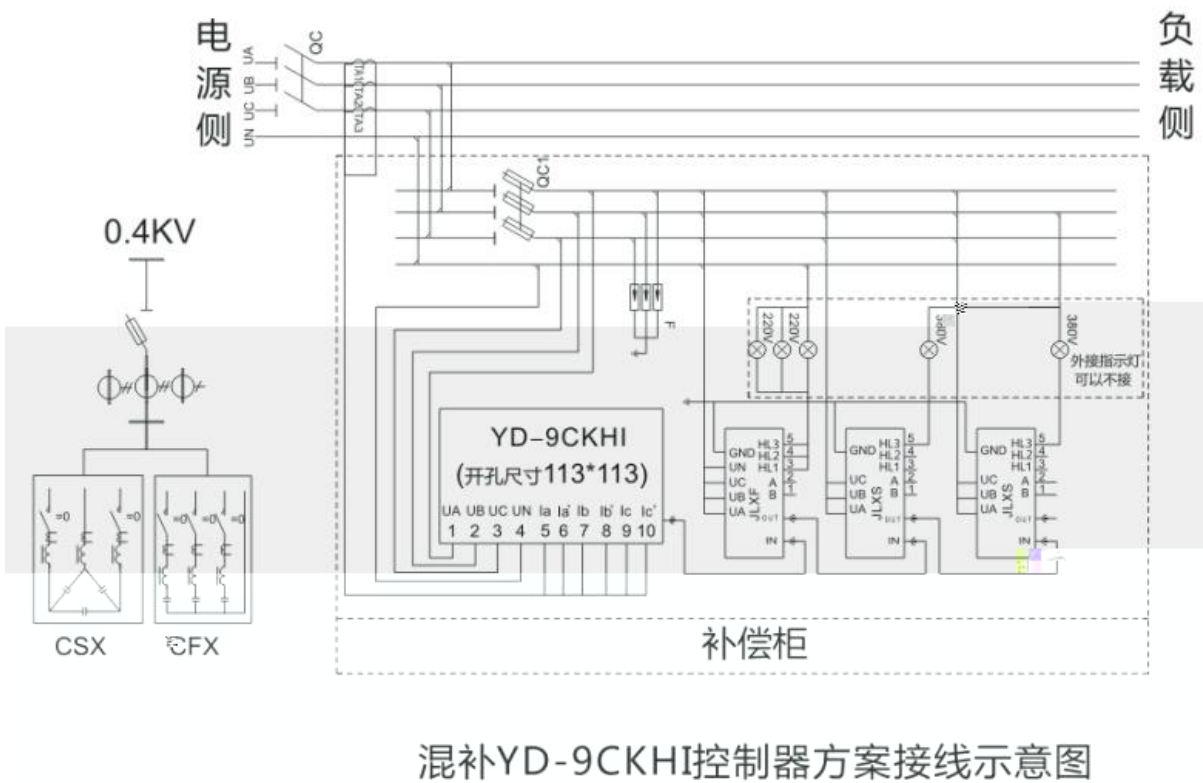
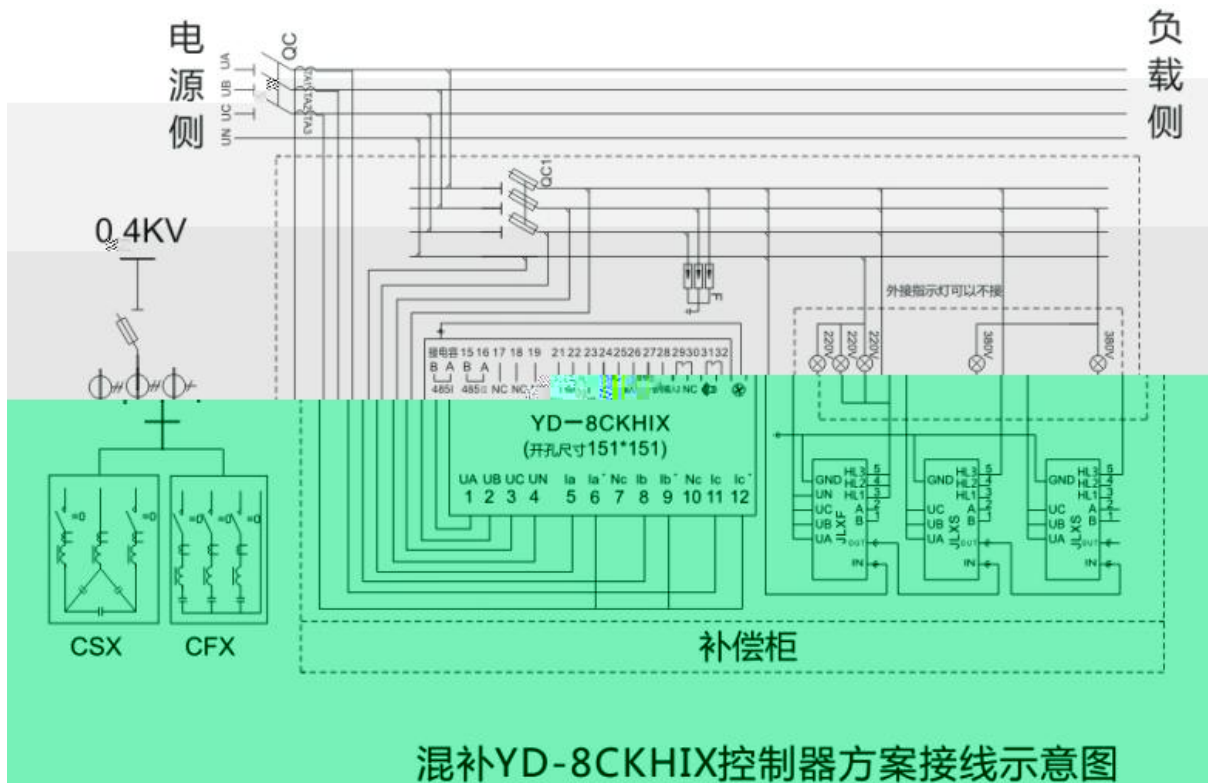



**2.**



**3.**

**1**

**2**

**3**

▪

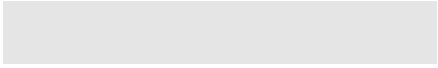





▪



2

---

---

1

2