

▪ [Redacted]

▪ [Redacted]

YDK-TSCJ□

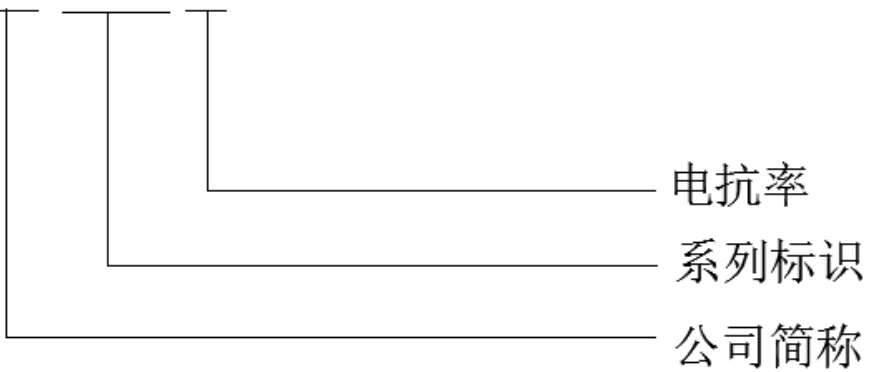

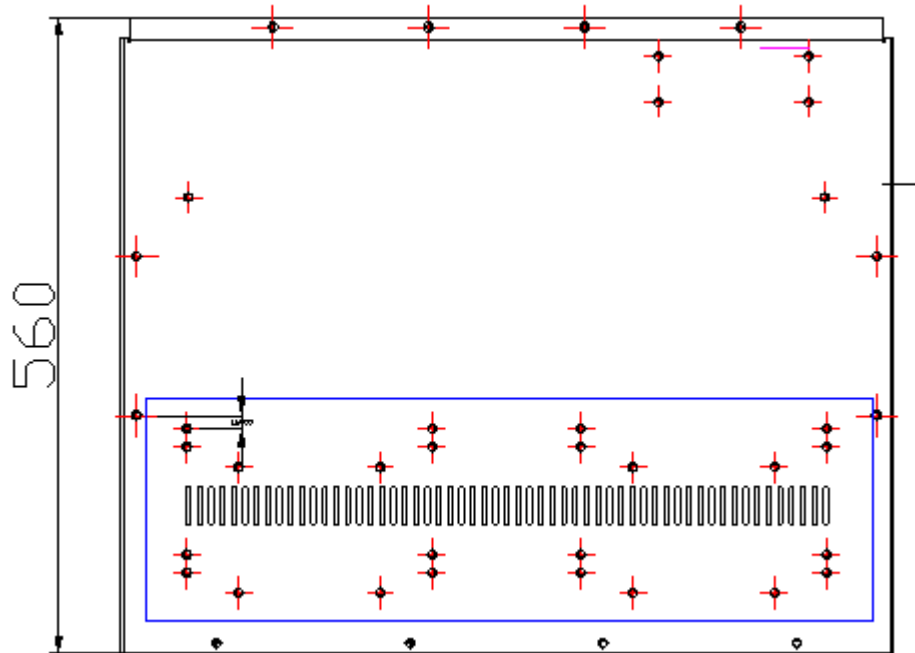
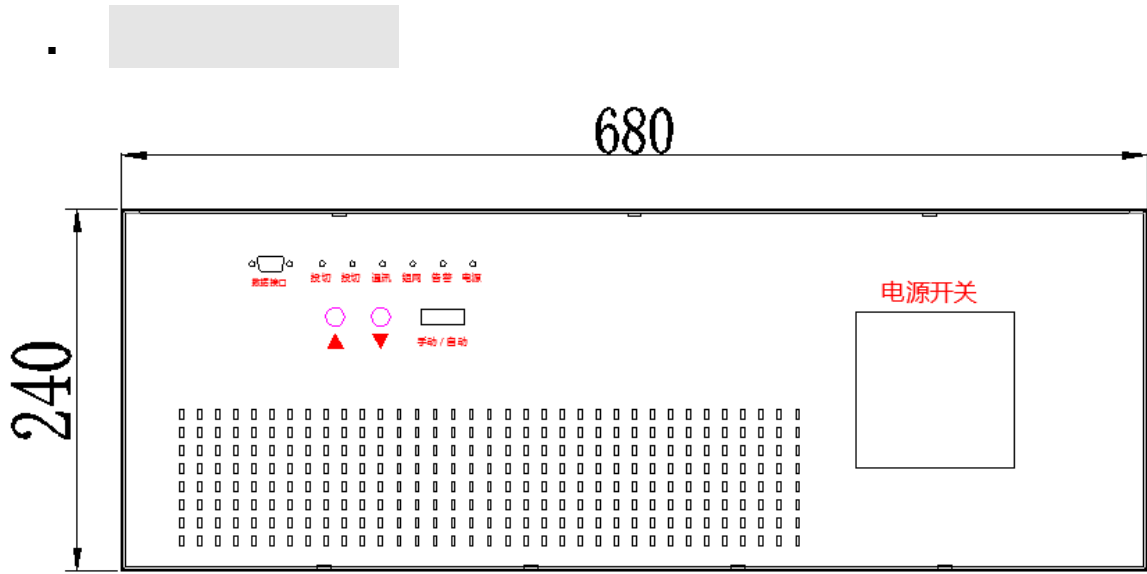

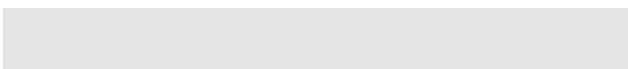
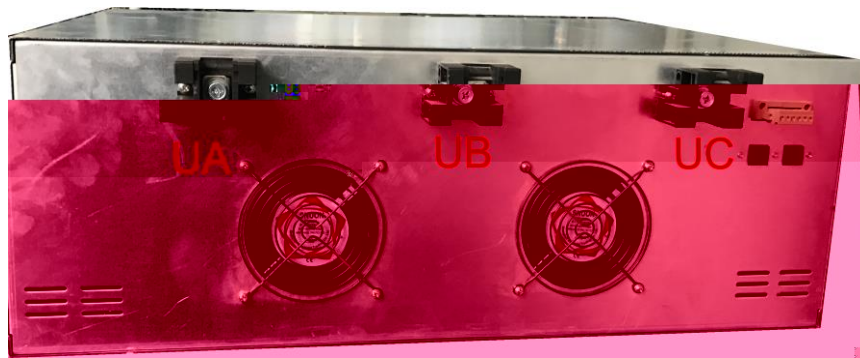









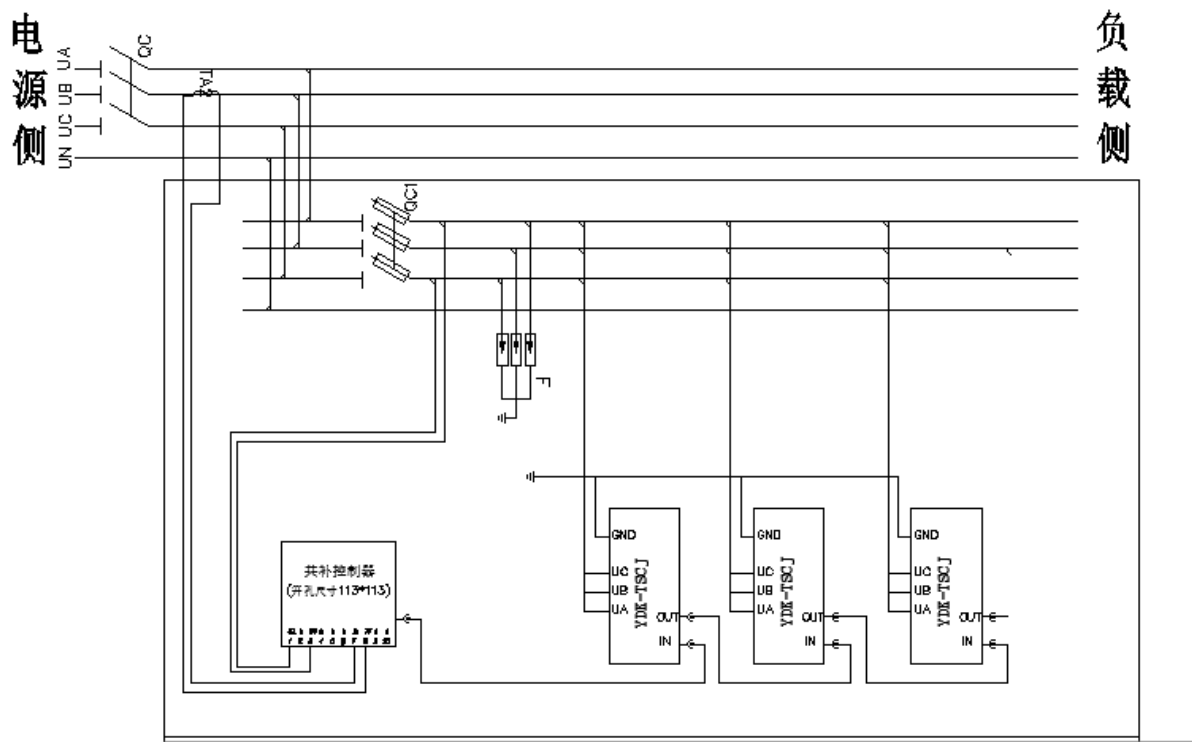

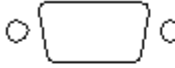
(35/25)mm² 多芯铜导线





数据接口

     
投切1 投切2 通讯 组网 告警 电源







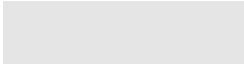

手动 / 自动

▪

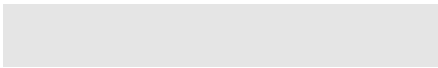

▪



--	--	--

